

## DC/DC CONVERTER CONTROL IC WITH CURRENT SENSE AMPLIFIER

### ■GENERAL DESCRIPTION

The **NJM2384** is a low voltage operation DC/DC converter control IC featuring high side current protection and soft start functions.

It is suitable for battery charger, power module application and on-board regulators.

### ■PACKAGE OUTLINE

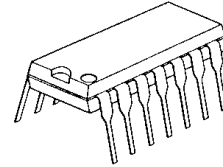

**NJM2384D**

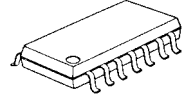

**NJM2384M**



**NJM2384V**

### ■FEATURES

- PWM switching control
- Operating Voltage                      3.6V to 32V
- Wide Oscillator Range                5kHz to 500 kHz
- Current Sensing Amplifier
- Soft-Start Function
- UVLO (Under Voltage Lockouts)
- Bipolar Technology
- Package Outline      DIP14, DMP14, SSOP10

### ■PIN CONFIGURATION

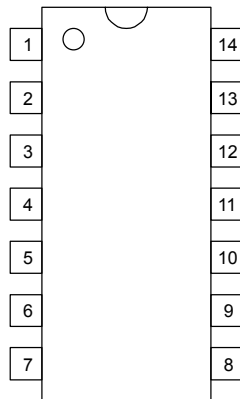

**NJM2384D**  
**NJM2384M**

#### PIN FUNCTION

1.NC	8.NC
2.IN <sup>-</sup> 1	9. V <sup>+</sup>
3.IN <sup>-</sup> 2	10.CS
4.F.B	11.CT
5.GND	12.REF
6.OUT	13.IN <sup>+</sup>
7.NC	14.NC

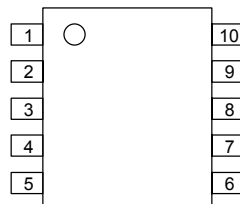

**NJM2384V**

#### PIN FUNCTION

1.IN <sup>-</sup> 1	6. V <sup>+</sup>
2.IN <sup>-</sup> 2	7.CS
3.F.B	8.CT
4.GND	9.REF
5.OUT	10.IN <sup>+</sup>

# NJM2384

## ■BLOCK DIAGRAM

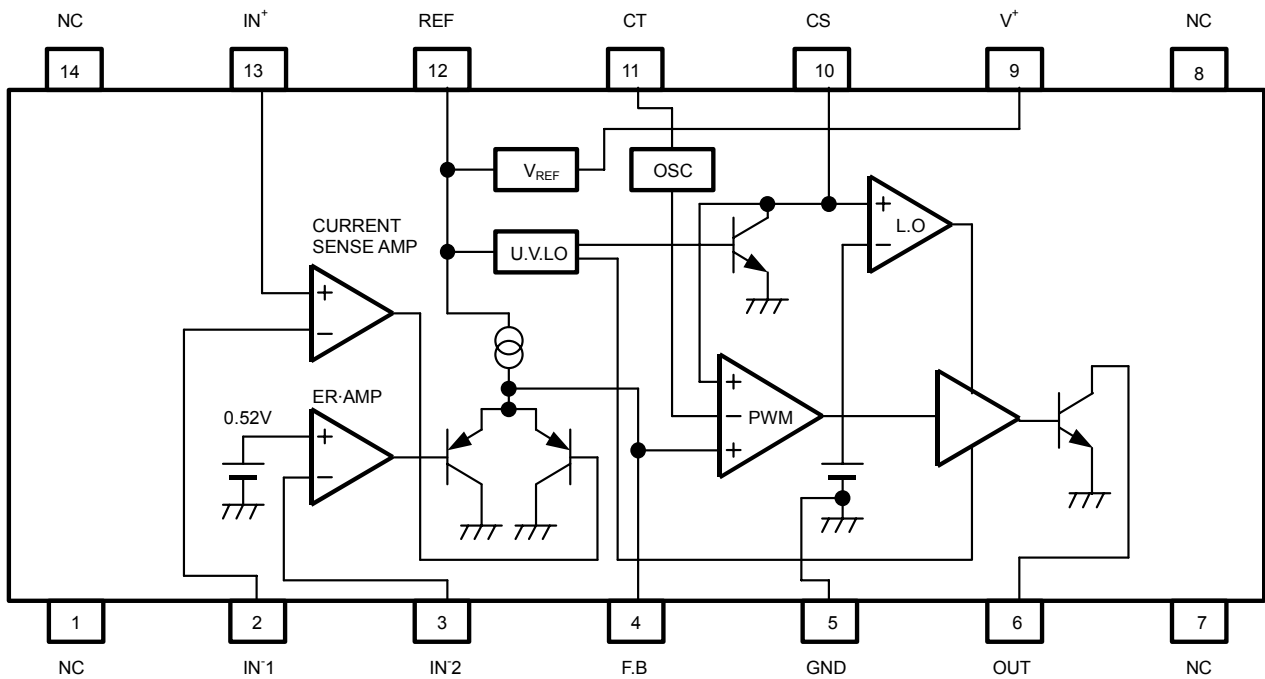

(Package: DIP14, DMP14)

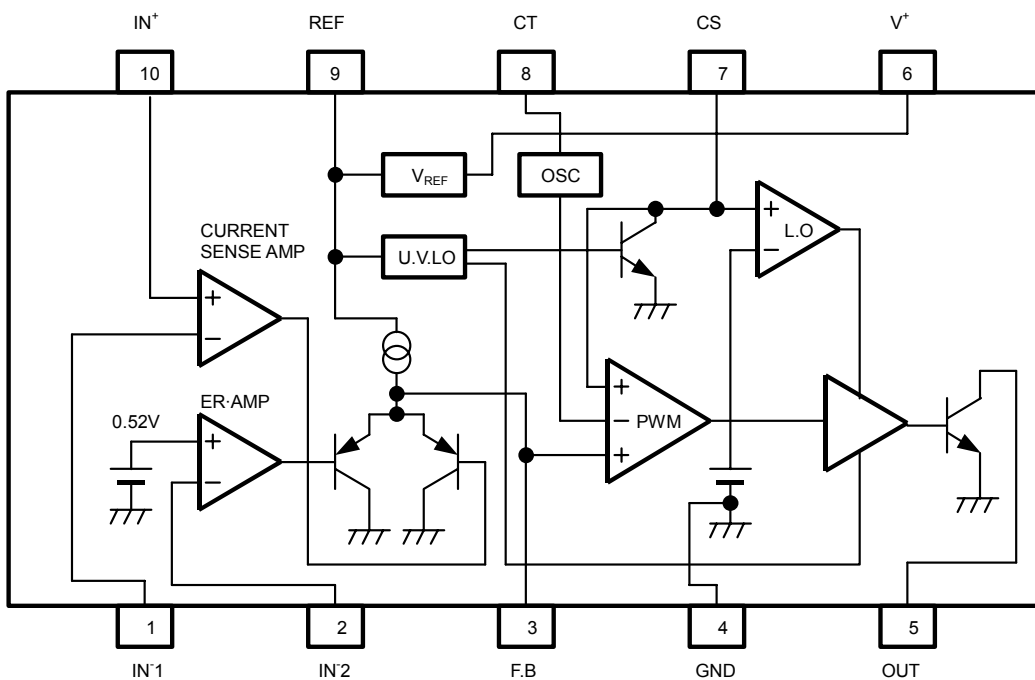

(Package: SSOP10)

## ■ABSOLUTE MAXIMUM RATINGS (Ta=25°C)

PARAMETER	SYMBOL	MAXIMUM RATINGS	UNIT
Input Voltage	V <sup>+</sup>	36	V
Reference Output Current	I <sub>OR</sub>	10	mA
Output Sink Current	I <sub>SINK</sub>	200	mA
Differential Input Voltage	V <sub>ID</sub>	2.5	V
Common Mode Input Voltage	V <sub>IC</sub>	-0.3 ~ 2.5	V
Power Dissipation	P <sub>D</sub>	(DIP 14) 700 (DMP 14) 300 (SSOP 10) 250	mW
Operating Temperature Range	T <sub>OPR</sub>	-40 ~ +85	°C
Storage Temperature Range	T <sub>STG</sub>	-50 ~ +150	°C

## ■ELECTRICAL CHARACTERISTICS (V<sup>+</sup>=6V, R<sub>T</sub>=33kΩ, C<sub>T</sub>=1000pF, Ta=25°C)

### REFERENCE VOLTAGE BLOCK

PARAMETER	SYMBOL	TEST CONDITION	MIN.	TYP.	MAX.	UNIT
Output Voltage	V <sub>REF</sub>	I <sub>OR</sub> =1mA	2.45	2.50	2.55	V
Line Regulation	L <sub>INE</sub>	V <sup>+</sup> =3.6 ~ 32V, I <sub>OR</sub> =1mA	-	6.8	20.7	mV
Load Regulation	L <sub>OAD</sub>	I <sub>OR</sub> =0.1 ~ 5.0mA	-	5	30	mV

### OSCILLATOR BLOCK

PARAMETER	SYMBOL	TEST CONDITION	MIN.	TYP.	MAX.	UNIT
Oscillation Frequency	f <sub>OSC</sub>	R <sub>T</sub> =33kΩ, C <sub>T</sub> =1000pF	85	105	125	kHz
Oscillate Fluctuations1 (Line Fluctuations)	f <sub>dV</sub>	V <sup>+</sup> =3.6 ~ 32V	-	1	-	%
Oscillate Fluctuations2 (Temp Fluctuations)	f <sub>dT</sub>	Ta=-40°C ~ 85°C	-	5	-	%

### CURRENT SENSE AMPLIFIER BLOCK

PARAMETER	SYMBOL	TEST CONDITION	MIN.	TYP.	MAX.	UNIT
Input Offset Voltage1	V <sub>IO1</sub>		-	2	7	mV
Input Offset Current1	I <sub>IO1</sub>		-	5	50	nA
Input Bias Current1	I <sub>B1</sub>		-	5	100	nA
Open Loop Gain1	A <sub>V1</sub>		-	90	-	dB
Gain Bandwidth Product1	G <sub>B1</sub>		-	0.6	-	MHz
Input Common Mode Voltage Ratio1	V <sub>ICM1</sub>		-	0 ~ V <sub>REF</sub> -0.8	-	V
Maximum Output Voltage1 (F.B Pin)	V <sub>OM-1</sub>	R <sub>NF</sub> =100kΩ	-	-	1	V
Maximum Source Current1 (F.B Pin)	I <sub>OM+1</sub>	V <sub>OM</sub> =0.5V	40	85	200	μA

# NJM2384

■ ELECTRICAL CHARACTERISTICS ( $V^+=6V, R_T=33k\Omega, C_T=1000pF, T_a=25^\circ C$ )

## ERROR AMPLIFIER BLOCK

PARAMETER	SYMBOL	TEST CONDITION	MIN.	TYP.	MAX.	UNIT
Reference Voltage <sub>2</sub>	$V_{B2}$		0.51	0.52	0.53	V
Input Bias Current <sub>2</sub>	$I_{B2}$		–	5	100	nA
Open Loop Gain <sub>2</sub>	$A_{V2}$		–	90	–	dB
Gain Bandwidth Product <sub>2</sub>	$G_{B2}$		–	0.6	–	MHz
Maximum Output Voltage <sub>2</sub> (F.B Pin)	$V_{OM-2}$	$R_{NF}=100k\Omega$	–	–	1	V
Maximum Source Current <sub>2</sub> (F.B Pin)	$I_{OM+2}$	$V_{OM}=0.5V$	40	85	200	$\mu A$

## PWM COMPARATE BLOCK

PARAMETER	SYMBOL	TEST CONDITION	MIN.	TYP.	MAX.	UNIT
Input Threshold Voltage (F.B Pin)	$V_{TH0}$	duty·cycle=0% (note)	–	1.65	1.75	V
Input Threshold Voltage (F.B Pin)	$V_{TH100}$	duty·cycle=100% (note)	–	2.10	–	V

## SOFT START CIRCUIT BLOCK

PARAMETER	SYMBOL	TEST CONDITION	MIN.	TYP.	MAX.	UNIT
Input Bias Current (CS Pin)	$I_{BCS}$	CS Pin=1.8V	–	250	650	nA
Input Threshold Voltage (CS Pin)	$V_{THCS0}$	duty·cycle=0% (note)	–	0.25	0.35	V
Input Threshold Voltage (CS Pin)	$V_{THCS50}$	duty·cycle=100% (note)	–	0.7	–	V

## UNDER VOLTAGE LOCKOUT BLOCK

PARAMETER	SYMBOL	TEST CONDITION	MIN.	TYP.	MAX.	UNIT
ON Threshold Voltage	$V_{THON}$		–	2.70	–	V
OFF Threshold Voltage	$V_{THOFF}$		–	2.52	–	V
Hysteresis Voltage	$V_{HYS}$		60	180	–	mV

## OUTPUT BLOCK

PARAMETER	SYMBOL	TEST CONDITION	MIN.	TYP.	MAX.	UNIT
L Output Voltage (OUT Pin)	$V_{OL}$	Output Sink Current=100mA	–	0.25	0.65	V

## GENERAL CHARACTERISTICS

PARAMETER	SYMBOL	TEST CONDITION	MIN.	TYP.	MAX.	UNIT
Latch Mode Threshold Voltage (CS Pin)	$V_{THLA}$		1.2	1.5	1.8	V
Quiescent Current	$I_{CCLA}$	Latch Mode	–	1.6	2.2	mA
Average Quiescent Current	$I_{CCAV}$	$RL = \infty$ , duty·cycle=50%	–	5.5	10	mA

(note) Duty·Cycle is defined as follows:

Duty·Cycle=0%: IC output transistor is OFF.

Duty·Cycle=100%: IC output transistor is ON.



## ■ TYPICAL CHARACTERISTICS

L Output Voltage vs. Source Current  
( $V^+=6V, R_T=33k\Omega, C_T=1000pF, T_a=25^\circ C$ )

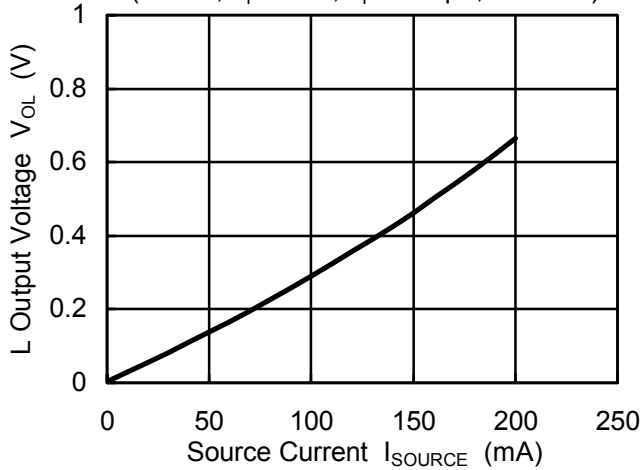

Duty Cycle vs. CS Pin Voltage  
( $V^+=6V, T_a=25^\circ C$ )

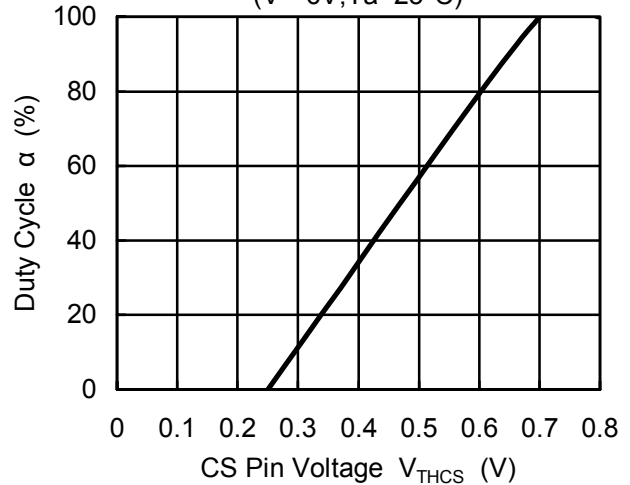

Oscillator Frequency vs. Timing Resistor  
( $V^+=6V, T_a=25^\circ C$ )

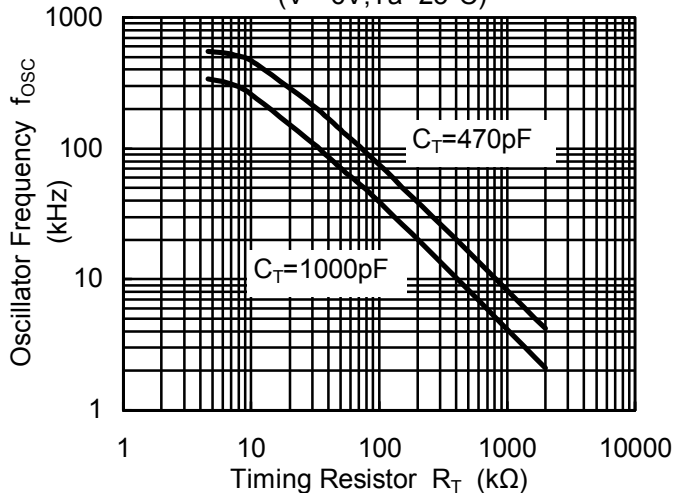

Oscillator Frequency vs. Timing Capacitor  
( $V^+=6V, T_a=25^\circ C$ )

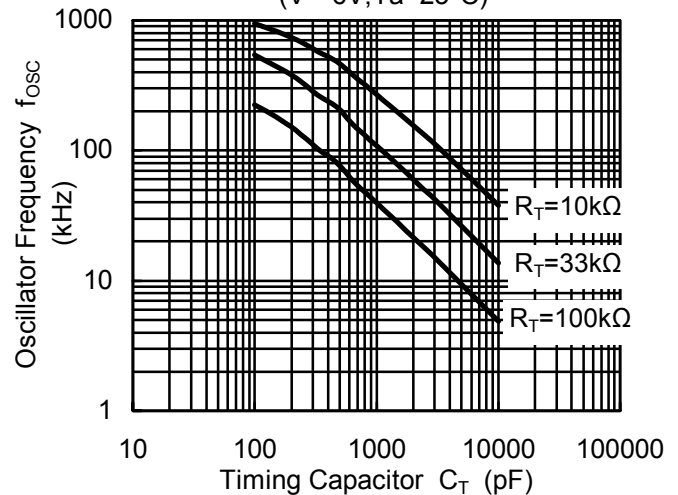

Reference Voltage vs. Operating Voltage  
( $V^+=6V, T_a=25^\circ C$ )

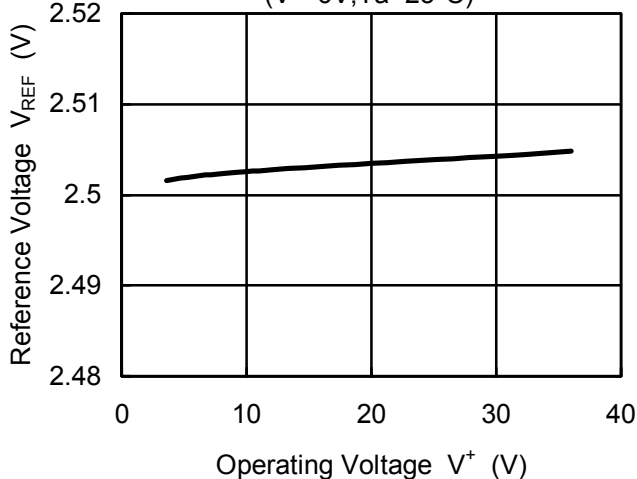

Operating Current vs. Operating Voltage  
( $T_a=25^\circ C$ )

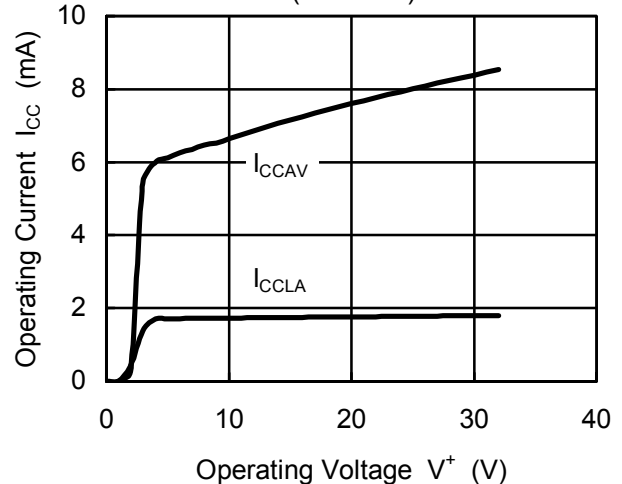

## ■ TYPICAL CHARACTERISTICS

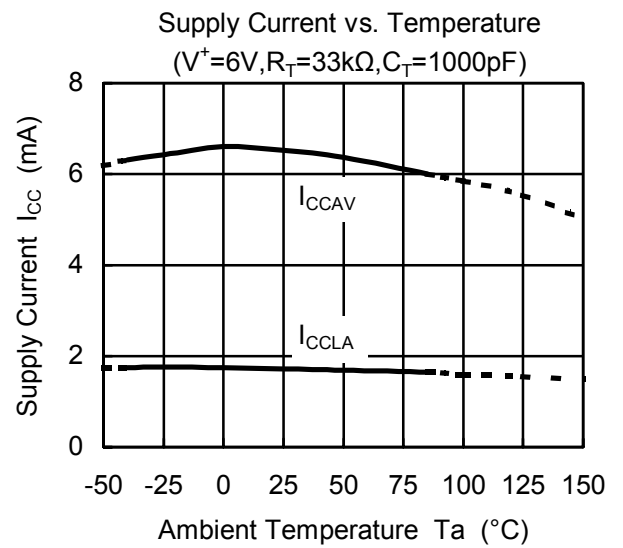
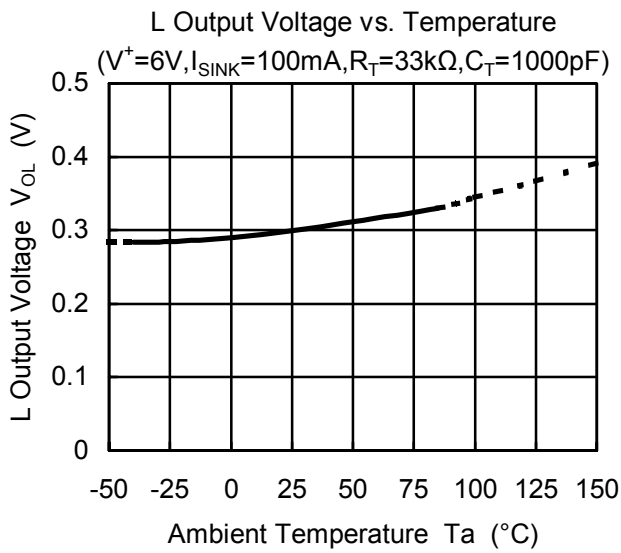
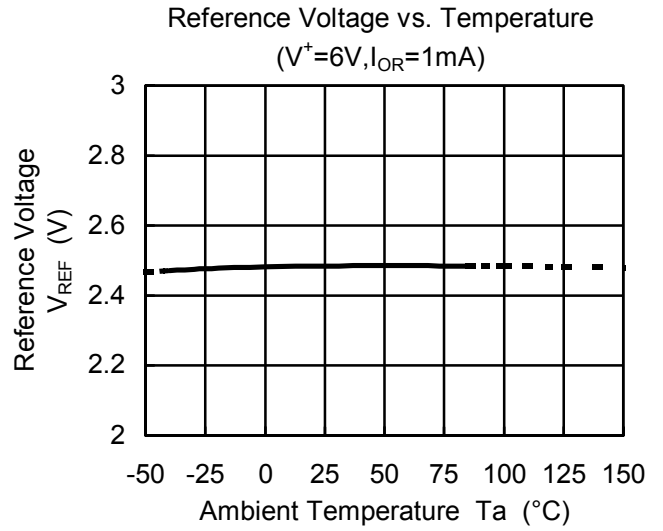
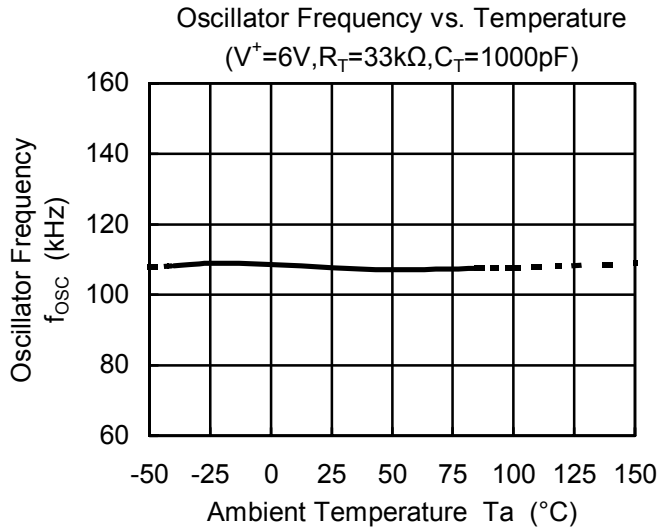

**[CAUTION]**  
The specifications on this databook are only given for information, without any guarantee as regards either mistakes or omissions. The application circuits in this databook are described only to show representative usages of the product and not intended for the guarantee or permission of any right including the industrial rights.